



PE11M Series 3.3 V PECL Clock Oscillators

December 2007

- Pletronics' PE11M Series is a quartz crystal controlled precision square wave generator with a PECL output.
- Minimizes RFI radiation, eases meeting FCC Class B emissions standards.
- Tube packaging is available.
- 1 to 250 MHz
- Full Size Thru-Hole DIP package
- No Enable/Disable Function
- 3rd Overtone Crystals used
- Low Jitter
- 5x7 mm LCC ceramic oscillator inside

**Pletronics Inc. certifies this device is in accordance with the
RoHS 5/6 (2002/95/EC) and WEEE (2002/96/EC) directives.**

Pletronics Inc. guarantees the device does not contain the following:

Cadmium, Hexavalent Chromium, Lead (< 1000 ppm), Mercury, PBB's, PBDE's

Weight of the Device: 3.76 grams

Moisture Sensitivity Level: 1 As defined in J-STD-020C

Second Level Interconnect code: e1

Absolute Maximum Ratings:

Parameter	Unit
V _{CC} Supply Voltage	-0.5V to +7.0V
V _i Input Voltage	-0.5V to V _{CC} + 0.5V
V _o Output Voltage	-0.5V to V _{CC} + 0.5V

Thermal Characteristics

The maximum die or junction temperature is 155°C

The thermal resistance junction to board is 120°C/Watt depending on the solder pads, ground plane and construction of the PCB.

Part Number:

PE11	45	M	E	V	-125.0M	-XX	
							Internal code or blank
							Frequency in MHz
							Supply Voltage V_{CC} $V = 3.3V \pm 10\%$
							Optional Enhanced OTR Blank = Temp. range -10 to +70°C E = Temp. range -40 to +85°C
							Series Model
							Frequency Stability 45 = ± 50 ppm 44 = ± 25 ppm 20 = ± 20 ppm
							Series Model

Part Marking:

PLE	or	PE11MX
PE11M		FFFFM
FFFFM		PLE XX
• YMDXX		• YYWWXX

Legend:

PLE = Pletronics
 FFFFFM = Frequency in MHz
 YMD or YYWW = Date of Manufacture (Year - month - day or year and week)
 All other marking is internal factory codes

Specifications such as frequency stability, supply voltage and operating temperature range, etc. are not identified from the marking. External packaging labels and packing list will correctly identify the ordered Pletronics part number.

Codes for Date Code YMD

Code	6	7	8	9	0	1	2
Year	2006	2007	2008	2009	2010	2011	2012

Code	A	B	C	D	E	F	G	H	J	K	L	M
Month	JAN	FEB	MAR	APR	MAY	JUN	JUL	AUG	SEP	OCT	NOV	DEC

Code	1	2	3	4	5	6	7	8	9	A	B	C
Day	1	2	3	4	5	6	7	8	9	10	11	12
Code	D	E	F	G	H	J	K	L	M	N	P	R
Day	13	14	15	16	17	18	19	20	21	22	23	24
Code	T	U	V	W	X	Y	Z					
Day	25	26	27	28	29	30	31					

Electrical Specification for 3.30V $\pm 10\%$ over the specified temperature range

Item	Min	Max	Unit	Condition
Frequency Range	1	250	MHz	
Frequency Accuracy "45"	-50	+50	ppm	For all supply voltages, load changes, aging for 1 year, shock, vibration and temperatures
"44"	-25	+25		
"20"	-20	+20		
Output Waveform	PECL /ECL			
Output High Level (0°C to 85°C)	2.275	2.420	volts	Referenced to Ground, $V_{CC} = 3.3 V$
	0.975	1.120	volts	Referenced to termination voltage, $V_{CC} = 3.3 V$
	-1.025	-0.880	volts	Referenced to Vcc, $V_{CC} = 3.3 V$
Output High Level (-40°C)	2.216	2.420	volts	Referenced to Ground, $V_{CC} = 3.3 V$
	0.916	1.120	volts	Referenced to termination voltage, $V_{CC} = 3.3 V$
	-1.084	-0.88	volts	Referenced to Vcc, $V_{CC} = 3.3 V$
Output Low Level (0°C to 85°C)	1.490	1.680	volts	Referenced to Ground, $V_{CC} = 3.3 V$
	0.190	0.380	volts	Referenced to termination voltage, $V_{CC} = 3.3 V$
	-1.810	-1.620	volts	Referenced to Vcc, $V_{CC} = 3.3 V$
Output Low Level (-40°C)	1.470	1.745	volts	Referenced to Ground, $V_{CC} = 3.3 V$
	0.170	0.445	volts	Referenced to termination voltage, $V_{CC} = 3.3 V$
	-1.830	-1.555	volts	Referenced to Vcc, $V_{CC} = 3.3 V$
Output Symmetry	45	55	%	at 50% point of V_{CC} (See load circuit)
Jitter	-	0.2	pS RMS	12 KHz to 20 MHz from the output frequency
	-	2.8	pS RMS	10 Hz to 1 MHz from the output frequency
Output T_{RISE} and T_{FALL}	-	0.7	nS	Vth is 20% and 80% of waveform
V_{CC} Supply Current (I_{CC})	-	90	mA	
Start up time	-	10	mS	Time for output to reach specified frequency
Operating Temperature Range	-10	+70	°C	Standard Temperature Range
	-40	+85	°C	Extended Temperature Range "E" Option
Storage Temperature Range	-55	+125	°C	

Load Circuit

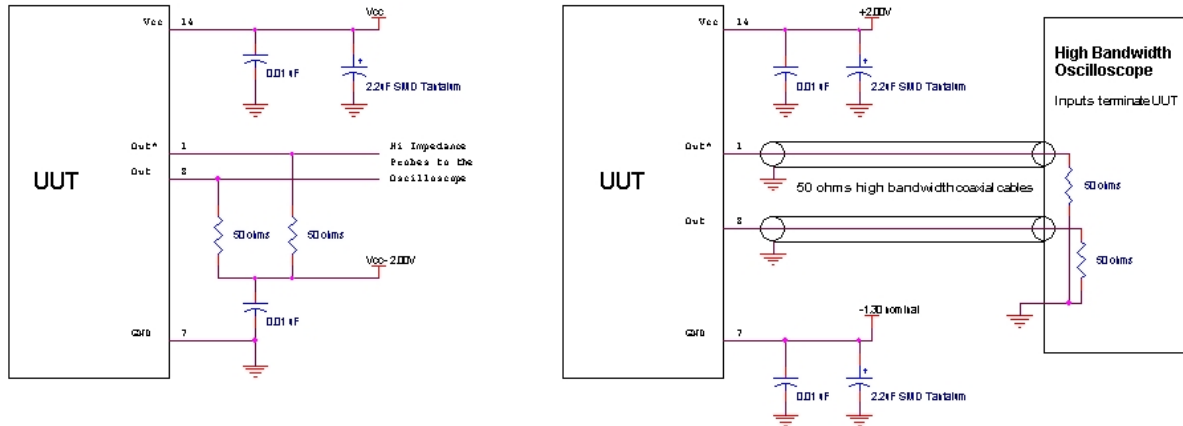

Test Waveform

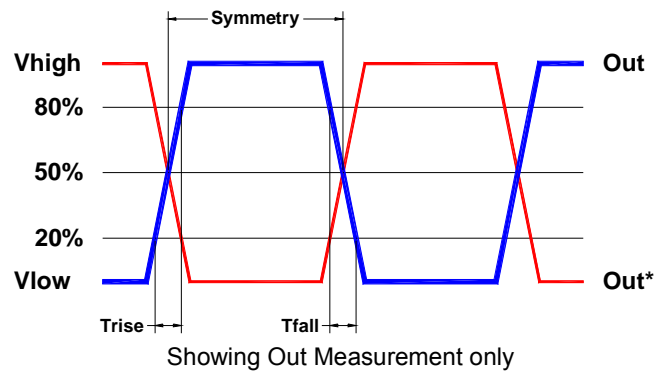

Reliability: Environmental Compliance

Parameter	Condition
Mechanical Shock	MIL-STD-883 Method 2002, Condition B
Vibration	MIL-STD-883 Method 2007, Condition A
Solderability	MIL-STD-883 Method 2003
Thermal Shock	MIL-STD-883 Method 1011, Condition A





ESD Rating

Model	Minimum Voltage	Conditions
Human Body Model	1500	MIL-STD-883 Method 3115
Charged Device Model	1000	JESD 22-C101

Package Labeling

Label is 1" x 2.6" (25.4mm x 66.7mm)
Font is Courier New
Bar code is 39-Full ASCII

Label is 1" x 2.6" (25.4mm x 66.7mm)
Font is Arial

P/N:		
	PE1145MV-100.0M	
Customer P/N:		
	12345678	
Qty:		D/C 
	1000	0626A3

RoHS Compliant
2nd Lvl Interconnect Category=e1
Max Safe Temp=245C for 10s (Reflow only) 2X Max
Max Safe Temp=280C for 15s (Wave solder only)

PCB Mounting

Wave solder at 255°C to 280°C with maximum wave exposure of 15 seconds
Reflow solder maximum exposure of 245°C for 15 seconds
Soldering done in a nitrogen atmosphere enhances the solder joint quality.

Mechanical:

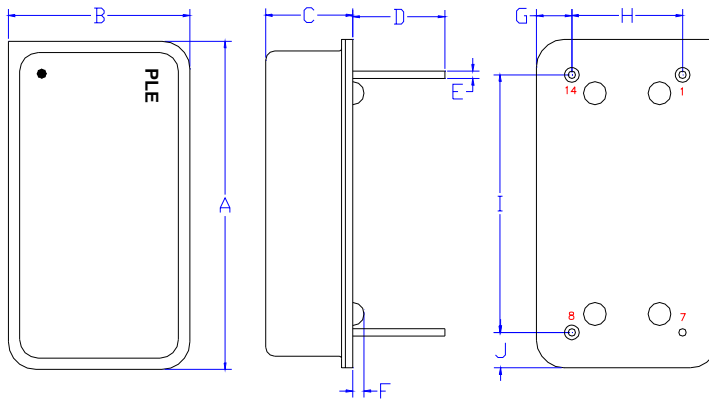

Cover:
Kovar
Electroless Nickel Plated
1 μinch (25 μm) typical
Resistance welded to base

Base:
Kovar
Glass to metal sealed leads

Label:
White Kapton with Black Letters
-or-

Blue Epoxy heat cure ink with laser
marked lettering

Pin 7 Connected to case

Not to scale

	Inches	mm
A	0.787 ±0.005	20.00 ±0.13
B	0.487 ±0.005	12.37 ±0.13
C	0.225 ±0.011	5.72 ±0.28
D ¹	0.250	6.35
E ¹	0.020	0.51
F ¹	0.031	0.79
G ¹	0.094	2.37
H ¹	0.300	7.62
I ¹	0.600	15.24
J ¹	0.094	2.37

¹ Nominal dimension

Pin	Function	Note
1	Output*	Both outputs must be terminated and biased for proper operation. The ideal termination is 50 ohms connected to 2.0V below the Supply Voltage.
7	Ground (GND)	
8	Output	Both outputs must be terminated and biased for proper operation. The ideal termination is 50 ohms connected to 2.0V below the Supply Voltage.
14	Supply Voltage (V _{CC})	Recommend connecting appropriate power supply bypass capacitors as close as possible.

Layout and application information

For Optimum Jitter Performance, Pletronics recommends:

- a ground plane under the device
- no large transient signals (both current and voltage) should be routed under the device
- do not layout near a large magnetic field such as a high frequency switching power supply
- do not place near piezoelectric buzzers or mechanical fans.



PE11M Series 3.3 V PECL Clock Oscillators

December 2007

IMPORTANT NOTICE

Pletronics Incorporated (PLE) reserves the right to make corrections, improvements, modifications and other changes to this product at anytime. PLE reserves the right to discontinue any product or service without notice. Customers are responsible for obtaining the latest relevant information before placing orders and should verify that such information is current and complete. All products are sold subject to PLE's terms and conditions of sale supplied at the time of order acknowledgment.

PLE warrants performance of this product to the specifications applicable at the time of sale in accordance with PLE's limited warranty. Testing and other quality control techniques are used to the extent PLE deems necessary to support this warranty. Except where mandated by specific contractual documents, testing of all parameters of each product is not necessarily performed.

PLE assumes no liability for application assistance or customer product design. Customers are responsible for their products and applications using PLE components. To minimize the risks associated with the customer products and applications, customers should provide adequate design and operating safeguards.

PLE products are not designed, intended, authorized or warranted to be suitable for use in life support applications, devices or systems or other critical applications that may involve potential risks of death, personal injury or severe property or environmental damage. Inclusion of PLE products in such applications is understood to be fully at the risk of the customer. Use of PLE products in such applications requires the written approval of an appropriate PLE officer. Questions concerning potential risk applications should be directed to PLE.

PLE does not warrant or represent that any license, either express or implied, is granted under any PLE patent right, copyright, artwork or other intellectual property right relating to any combination, machine or process which PLE product or services are used. Information published by PLE regarding third-party products or services does not constitute a license from PLE to use such products or services or a warranty or endorsement thereof. Use of such information may require a license from a third party under the patents or other intellectual property of the third party, or a license from PLE under the patents or other intellectual property of PLE.

Reproduction of information in PLE data sheets or web site is permissible only if the reproduction is without alteration and is accompanied by associated warranties, conditions, limitations and notices. Reproduction of this information with alteration is an unfair and deceptive business practice. PLE is not responsible or liable for such altered documents.

Resale of PLE products or services with statements different from or beyond the parameters stated by PLE for that product or service voids all express and implied warranties for the associated PLE product or service and is an unfair or deceptive business practice. PLE is not responsible for any such statements.

Contacting Pletronics Inc.

Pletronics Inc.
19013 36th Ave. West
Lynnwood, WA 98036-5761 USA

Tel: 425-776-1880
Fax: 425-776-2760
E-mail: ple-sales@pletronics.com
URL: www.pletronics.com

Copyright © 2006, 2007 Pletronics Inc.

PLETRONICS INC. DOCUMENT CONTROL



PE11M Series 3.3 V PECL Clock Oscillators

December 2007

This is the document control page. **This is not printed or part of the PDF that can be downloaded on the web site.** This is to keep the history of the datasheet document and all revisions.

Part Number Family: PECL M, B PKG
Document File Name: PE11M 3.3V.wpd
PDF File Name: PE11M 3.3V.pdf
Written By: R Gubser
Approved By: Melody Mistlin and Claude Lee after sales and engineering group review.

This specification was written for the following configurations:
using SM77 and AZ100ELT20 IC inside OR using PE77D 3.3V inside (not available yet)

Revision History:

May 2006	Initial Release
July 28, 2007	Changed the A dimension of package 0.887 to 0.787 rag
Dec 2007	Deleted * in front of output in pinout table, updated temp range from 0-70 to -10-70, added YMD codes, updated RoHS label